

# Technische fiche

Borgmoer, PG-schroefdraad, lichtgrijs

Artikelnummer: 2048167



Borgmoer conform DIN 46320, met PG-schroefdraad conform DIN 40430.



PA Polyamide

## Stamgegevens

Artikelnummer	2048167
Type	116 VDE PG16 PA
Omschrijving 1	Wartelmoer
Fabrikant	OBO
Dimensie	PG16
Kleur	lichtgrijs; RAL 7035
Materiaal	Polyamide
Kleinste verkoop-eenheid	100
Eenheid van hoeveelheid	Stuk
Gewicht	0,325 kg
Eenheid gewicht	kg/100 paar

# Technische fiche

Borgmoer, PG-schroefdraad, lichtgrijs

Artikelnummer: 2048167



## Afmetingen



Afmeting e	33 mm
Maat L	6 mm

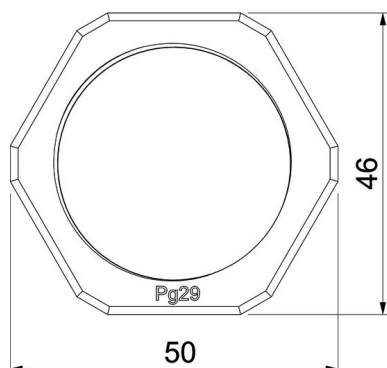
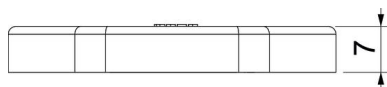
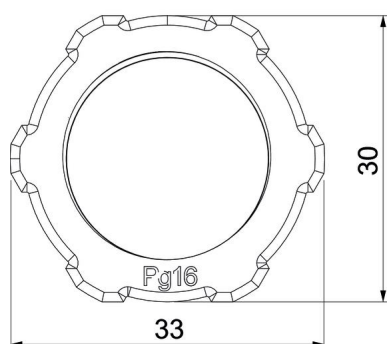

## Technische gegevens

Schroefdraad	Pg_16
Soort schroefdraad	Pg
Nominale schroefdraadmaat metrisch/PG	16
glasvezelversterkt	nee
Halogeenvrij	ja
slagvast	nee
Sleutelwijdte	30