

Technical data sheet

Beam clamp, horizontal A2

Item number: 6003964



Beam clamp for mounting light components on horizontal steel beams. Suitable, for example, for mesh cable trays and cable trays to 300 mm width or clips. The direction of the cable support system attached to the beam clamp is horizontal.

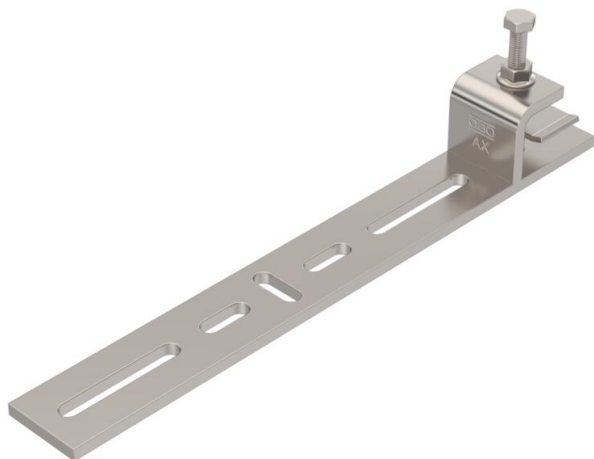

A2 Stainless steel

2B Bright, treated

Master data

Item number	6003964
Type	BFK W 250 A2
Description 1	Clamping piece
Description 2	for horizontal application
Available from	01.03.2026
Manufacturer	OBO
Dimension	318x44x40
Colour	stainless steel
Material	Stainless steel 1.4301
Surface	Bright, treated
Surface standard	
Smallest sales unit	10
Unit of quantity	Piece
Weight	68.366 kg
Weight unit	kg/100 pc.

Technical data sheet

Beam clamp, horizontal A2

Item number: 6003964



Dimensions

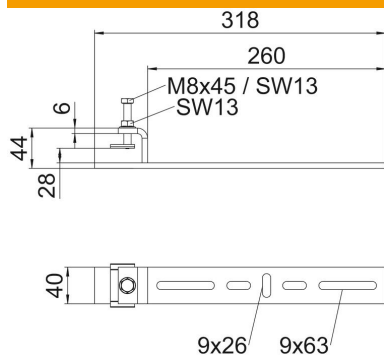

Length	318 mm
Width	260 mm
Height	32 mm

Technical data

Material thickness	6 mm
Rustproof steel, pickled	yes
Permitted temperature range, max.	120 °C
Permitted temperature range, min.	-20 °C