

Technical data sheet

Beam clamp horizontal FT

Item number: 6003920



Beam clamp for mounting light components on horizontal steel beams. Suitable, for example, for mesh cable trays and cable trays to 300 mm width or clips. The direction of the cable support system attached to the beam clamp is horizontal.



St Steel

FT Hot-dip galvanised

Master data

Item number	6003920
Type	BFK W 250 FT
Description 1	Clamping piece
Description 2	for horizontal application
Available from	01.03.2026
Manufacturer	OBO
Dimension	318x44x40
Colour	zinc
Material	Steel
Surface	Hot-dip galvanised
Surface standard	DIN EN ISO 1461
Smallest sales unit	10
Unit of quantity	Piece
Weight	71.21 kg
Weight unit	kg/100 pc.

Technical data sheet

Beam clamp horizontal FT

Item number: 6003920



Dimensions

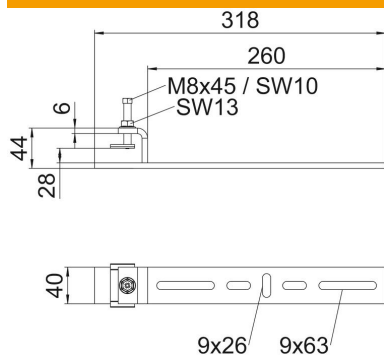

Length	318 mm
Width	260 mm
Height	32 mm

Technical data

Material thickness	6 mm
Rustproof steel, pickled	no
Permitted temperature range, max.	120 °C
Permitted temperature range, min.	-20 °C