

# Technical data sheet

## Wiring trunking, type LK4H 30030

Item number: 6132540

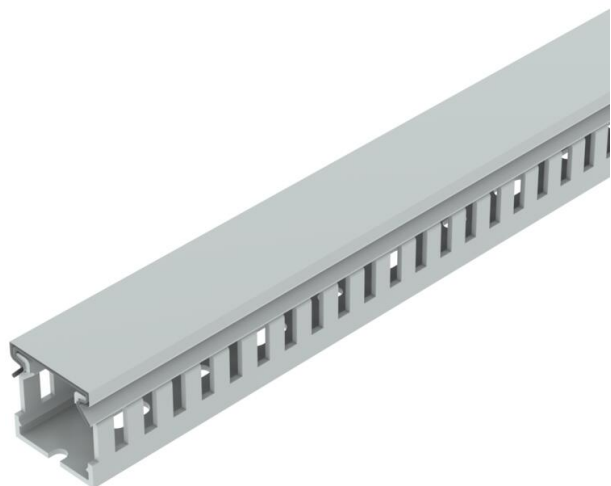

Halogen-free wiring duct, incl. cover and base perforation, for horizontal and vertical routing of electrical cables in the switchgear cabinet. With double-sided adhesive tape on the duct base as a mounting aid. Designed as a metric duct. Retainers are broken out without tools. Special lengths on request. Tested to DIN EN 50085-2-3. Base and cover in set.



Polycarbonate/Acrylnitrile-butadiene-styrene

### Master data

|                     |                                              |
|---------------------|----------------------------------------------|
| Item number         | 6132540                                      |
| Type                | LK4H 30030                                   |
| Description 1       | Slotted cable trunking system                |
| Description 2       | halogen-free                                 |
| Manufacturer        | OBO                                          |
| Colour              | Light grey; RAL 7035                         |
| Material            | Polycarbonate/Acrylnitrile-butadiene-styrene |
| Smallest sales unit | 2                                            |
| Unit of quantity    | Metre                                        |
| Weight              | 18 kg                                        |
| Weight unit         | kg/100 m                                     |

# Technical data sheet

## Wiring trunking, type LK4H 30030

Item number: 6132540



### Dimensions

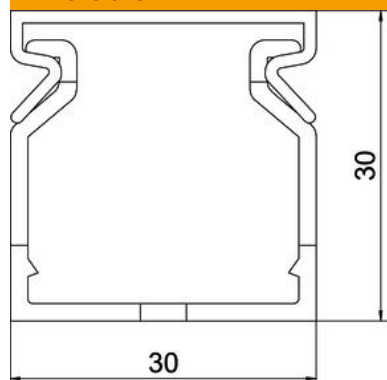

|        |          |
|--------|----------|
| Length | 2,000 mm |
| Width  | 30 mm    |
| Height | 30 mm    |

### Technical data

|                                   |                      |
|-----------------------------------|----------------------|
| Side wall version                 | Slotted              |
| Fastening type                    | Base perforation     |
| Flexible                          | no                   |
| Halogen-free                      | yes                  |
| Creepage current-resistant        | yes                  |
| With cover                        | yes                  |
| Usable cross-section              | 6.31 cm <sup>2</sup> |
| Slot spacing                      | 5.5 mm               |
| Slot width                        | 4.5 mm               |
| Self-extinguishing                | yes                  |
| Permitted temperature range, max. | 90 °C                |
| Permitted temperature range, min. | -25 °C               |