

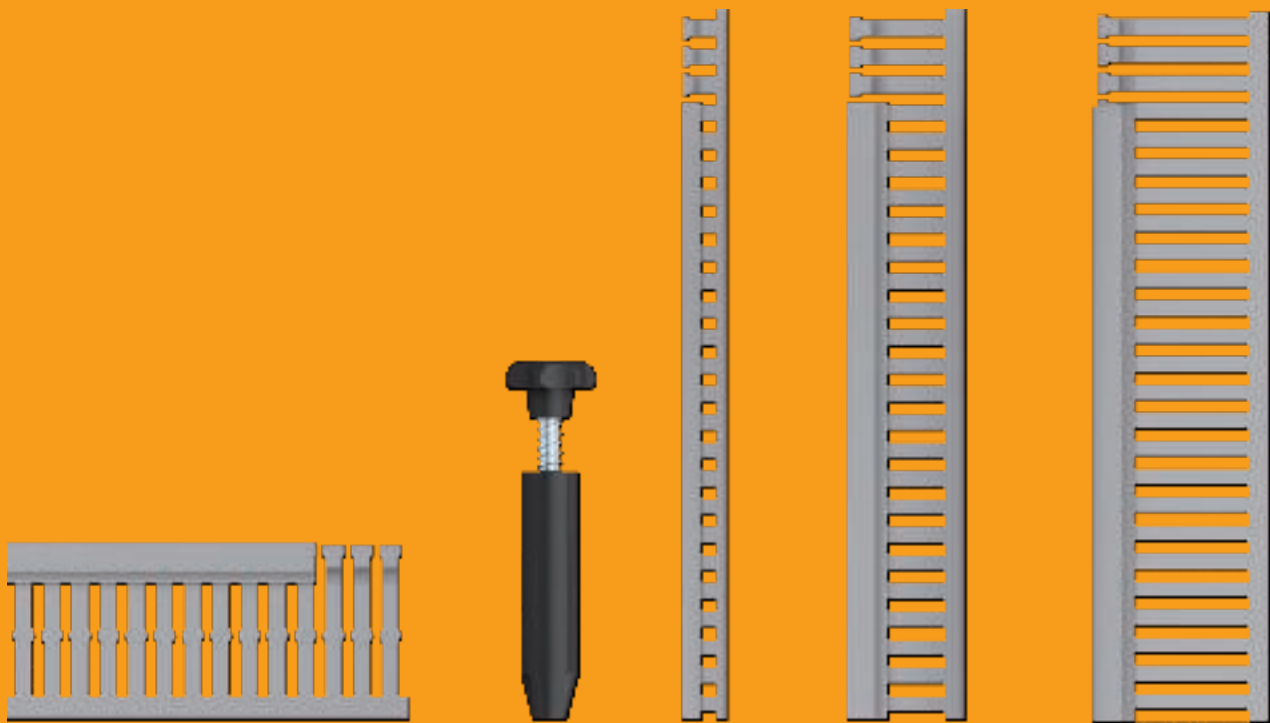

Bedradingskokers



OBO bedradingskokers



Een ongewoon breed programma met producten in de bekende hoge kwaliteit: de bedradingskokers zorgen voor een praktische installatie van kabels in de schakelkast. Alle kanalen zijn van loodvrij materiaal gefabriceerd. Voor optimale veiligheid hebben zij een programma halogeenvrije kanalen in het assortiment.

Voor de professionele bedradingsinstallatie staan de VK bedradingskokers ter beschikking in de afmetingen 15 x 15 mm tot 100 x 100 mm. Zachte, braamvrije sleuven en afgeronde tongen vergemakkelijken de montage en voorkomen verwondingen. Op aanvraag leveren wij ook speciale uitvoeringen.

OBO
BETTERMANN

Exacte maten en beproefde kwaliteit.

De bedradingskokers LK4 en LK4/N en ook LKV en LKV/N hebben nauwkeurig voorbereide breukplaatsen voor het eenvoudig uitbreken van de zijschotten. Alle types hebben, afhankelijk van de grootte, één of twee rijen bodemperforatie. Verjongingen in de zijgleuven van de typen LK4/N en LKV/N voorkomen dat de kabels uit de koker vallen.

LK4

Nominale maten zijn binnenmaten

LKV

Alleen buitenmaten

Gecertificeerd

De bedradingskokers zijn VDE-getest en UL-gecertificeerd (UL File E301798).



LK4 en LK4/N

OBO levert de bedradingskoker LK4 in de afmetingen 15 x 15 mm tot 80 x 120 mm. Het deksel zit goed vast, toch kan het eenvoudig worden afgenomen om het kanaal te openen.



LKV en LKV/N

Dankzij hun speciale vorm passen de deksels ook perfect op de LKV bedradingskokers. De LKV is leverbaar in de afmetingen 25 x 25 mm tot 100 x 100 mm (DIN EN 50085-2-3) en voldoet zo aan elke wens.



LKV/H

De LKV/H bedradingskoker is halogeenvrij en leverbaar in acht verschillende afmetingen van 50 x 37,5 mm tot 75 x 125 mm.

**HALOGEN
FREE**

- Geringe rookontwikkeling
- Geringe toxiciteit van de rookgassen
- Nauwelijks vrijkomen van corrosieve gassen

Opbouwsysteem Bedradingskokers



OBO bedradingskokers overtuigen met vele voordelen, welke zich in de schakelkastbouw al lange tijd hebben bewezen. Ook in continu bedrijf waarborgen deze de betrouwbare verbindingen en de goede werking van de elektrotechnische infrastructuur.

1

Stabiele kanalen met kwalitatieve wanddikten.

2

Exacte breukplaatsen dwars en in de bodem

3

Zachte, braamvrije sleuven, afgeronde tongen

4

Absolute maatvoering van de zijperforatie en de bodemperforatie

5

Snijkanten in afsluitbereik braamvrij afgerond

6

Vaste bevestiging van de deksel door optimale afsluitcontouren

7

Draadbevestigingslip, maakt bedrading zonder draadklem mogelijk en voorkomt uitvallen van al geïnstalleerde draden



Speciale oplossingen

- Beginmaat van de bodemperforatie variabel instelbaar
- Levering zonder bodemperforatie
- Speciale lengten
- Speciale kleuren



Uitbreektang

Met behulp van de uitbreektang kunnen de lamellen tot aan de kanaalbodem worden afgebroken. Na het uitbreken van de zijschotten ontstaat geen volumeverlies in de overgangszone naar het aansluitende kanaal.



Montage bedradingskoker

Met behulp van de splijtnagels wordt de bedradingskoker op de montageplaat van de schakelkast bevestigd. De splijtnagels worden met het kunststof nietapparaat gemonteerd.



Montage afstandshouder

Met de afstandshouder kan de bedradingskoker vanaf de montageplaat verhoogd gemonteerd worden.



Montage draadhouder

De draadhouder wordt in de zijleuf van de bedradingskokers ingebracht. Deze vergemakkelijkt de installatie van de kabel en houdt deze vast in de bedradingskoker. Hierdoor wordt het eenvoudiger om het deksel te plaatsen. Bij een eventuele installatie achteraf worden de kabels bij het wegnemen van het deksel in het kanaal vastgehouden zodat ze er niet uit vallen.



Draadhouders

De draadhouderbruggen kunnen aan de kanaalbreedte worden aangepast. Hiervoor wordt de draadhouderbrug op de breukplaatsen afgebroken. Daardoor is slechts één draadhouderbrug voor alle kanaalbreedtes nodig.

Bodemperforatie

Een- en tweespoor bodemperforatie conform DIN 43659 maken exact werken mogelijk.

Speciale oplossing

Beginmaat van de vloerperforatie variabel instelbaar naar wens van de klant



Identificatieplaatje

Sticker als markering voor het aanbrengen op bedradingskokers in schakelkasten waarin intrinsiekveilige circuits worden geïnstalleerd.



Gatenpatroon en maatvoering

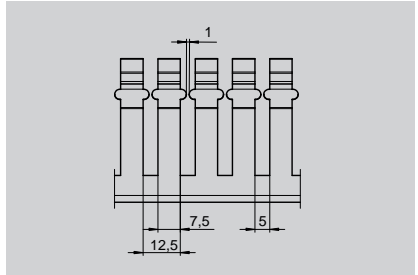
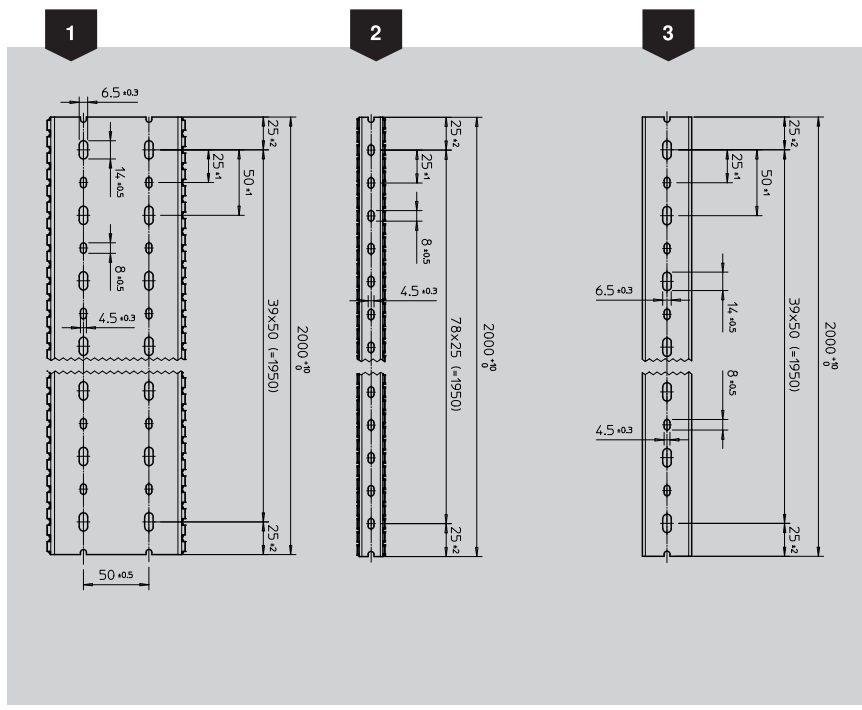

LKV

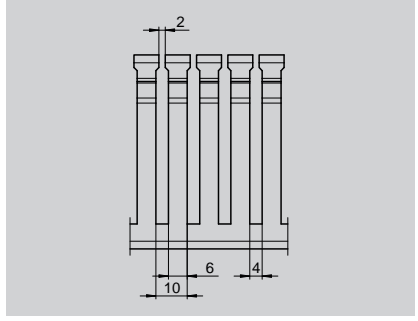

LK4

Alle VK- en VKH-bedradingskokers beginnen en eindigen, gerelateerd aan een leveringslengte (2000 mm), altijd met een half (4,5 x 8 mm) bevestigingsgat.

LK4/LK4/N	Art.nr.	Gatenpatroon
LK4 15015	6178001	2
LK4 30015	6178003	2
LK4 30025	6178005	3
LK4 40025	6178010	3
LK4 40040	6178012	3
LK4 40060	6178014	3
LK4 40080	6178016	1
LK4 40100	6178018	1
LK4 60015	6178026	2
LK4/N 60015	6178201	2
LK4 60025	6178028	3
LK4/N 60025	6178203	3
LK4 60040	6178031	3
LK4/N 60040	6178205	3
LK4 60060	6178033	3
LK4/N 60060	6178207	3
LK4 60080	6178035	1
LK4/N 60080	6178209	1
LK4 60100	6178037	1
LK4/N 60100	6178211	1
LK4 60120	6178039	1
LK4/N 60120	6178213	1

LK4/LK4/N	Art.nr.	Gatenpatroon
LK4 80025	6178050	3
LK4/N 80025	6178225	3
LK4 80040	6178052	3
LK4/N 80040	6178227	3
LK4 80060	6178054	3
LK4/N 80060	6178229	3
LK4 80080	6178056	1
LK4/N 80080	6178231	1
LK4 80100	6178059	1
LK4/N 80100	6178233	1
LK4/N 80120	6178236	1
LK4/N 80120	6178236	1
LK4/N 80120	6178236	1

LKV/H	Art.nr.	Gatenpatroon
LKVH 50037	6178582	3
LKVH 50050	6178585	3
LKVH 50075	6178588	1
LKVH N 75037	6178552	3
LKVH N 75050	6178556	3
LKVH N 75075	6178559	1
LKVH N 75100	6178563	1
LKVH N 75125	6178566	1

LKV/LKV/N	Art.nr.	Gatenpatroon
LKV 25025	6178302	3
LKV 37025	6178305	3
LKV 37037	6178307	3
LKV 50025	6178310	3
LKV 50037	6178312	3
LKV 50050	6178314	3
LKV 50075	6178316	1

LKV/LKV/N	Art.nr.	Gatenpatroon
LKV 75025	6178320	3
LKV/N 75025	6178420	3
LKV 75037	6178322	3
LKV 75037	6178422	3
LKV 75050	6178324	3
LKV/N 75050	6178424	3
LKV 75075	6178326	1
LKV/N 75075	6178426	1
LKV 75100	6178328	1
LKV/N 75100	6178428	1
LKV 75125	6178330	1
LKV/N 75125	6178430	1
LKV 10037	6178334	3
LKV/N 10037	6178435	3
LKV 10050	6178336	3
LKV/N 10050	6178437	3
LKV 10075	6178338	1
LKV/N 10075	6178439	1
LKV 100100	6178341	1

Afmeting bedradingskoker LK4

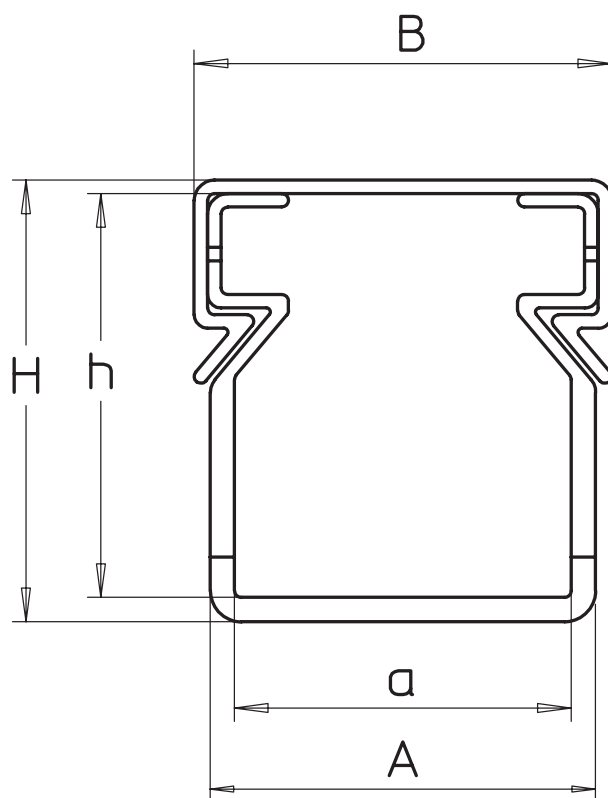

Afmetingen LK4

Art.nr.	Type	Art.nr.	Type	Maat a mm	Maat A mm	Maat B mm	Maat h mm	Maat H mm
6178001	LK4 15015			15	17	20	15	17
6178003	LK4 30015			15	17,8	20	30	32,4
6178005	LK4 30025			25	28,6	31	30	32,8
6178010	LK4 40025			25	28,6	31	40	42,8
6178012	LK4 40040			40	43,6	46,2	40	43
6178014	LK4 40060			60	64	66,4	40	43,2
6178016	LK4 40080			80	84	87	40	43,5
6178018	LK4 40100			100	104	107,4	40	43,7
6178026	LK4 60015	6178201	LK4 N 60015	15	18,6	20	60	62,8
6178028	LK4 60025	6178203	LK4 N 60025	25	29	31	60	63
6178031	LK4 60040	6178205	LK4 N 60040	40	44	46,2	60	63
6178033	LK4 60060	6178207	LK4 N 60060	60	64	66,4	60	63,2
6178035	LK4 60080	6178209	LK4 N 60080	80	84,4	87	60	63,7
6178037	LK4 60100	6178211	LK4 N 60100	100	104,6	107,4	60	64
6178039	LK4 60120	6178213	LK4 N 60120	120	124,6	127,8	60	64,2
6178050	LK4 80025	6178225	LK4 N 80025	25	29,4	31	80	83,2
6178052	LK4 80040	6178227	LK4 N 80040	40	44,4	46,2	80	83,3
6178054	LK4 80060	6178229	LK4 N 80060	60	64,4	66,4	80	83,4
6178056	LK4 80080	6178231	LK4 N 80080	80	84,6	87	80	83,9
6178059	LK4 80100	6178233	LK4 N 80100	100	104,8	107,4	80	84,1
6178061	LK4 80120	6178236	LK4 N 80120	120	124,8	127,8	80	84,3

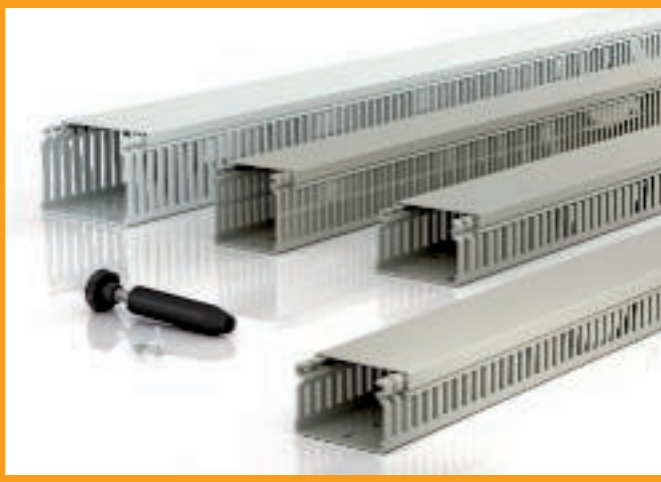

VK bedradingskoker

VK bedradingskokersysteem

	LK4 bedradingskoker	14
	LK4/N bedradingskoker met draadbevestiging	20
	LKV DIN bedradingskoker	24
	LKV/N DIN bedradingskoker met draadbevestiging	29
	Toebehoren	32

Bedradingskoker, type LK4 15015

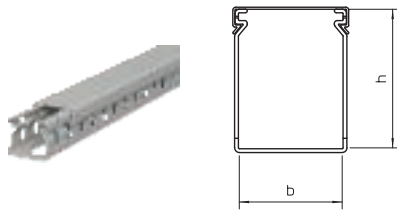

Type	Kleur	Lengte mm	B x H mm	Verp. m	Gewicht kg/100 m	Bestelnr.
LK4 15015	steengrijs	2000	15x15	72	12,000	6178001

PVC Polyvinylchloride €/m

Deksel

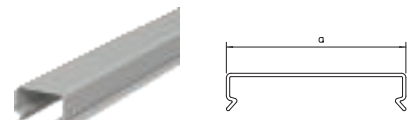

Type	Kleur	Afmeting a mm	Lengte mm	Verp. m	Gewicht kg/100 m	Bestelnr.
LK4 D 15	steengrijs	20	2000	92	8,500	6178480

PVC Polyvinylchloride €/m

Deksel

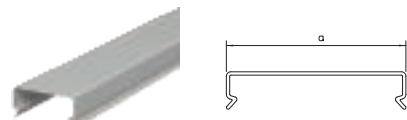

Type	Kleur	Afmeting a mm	Lengte mm	Verp. m	Gewicht kg/100 m	Bestelnr.
LK4 D 25	steengrijs	31	2000	32	10,000	6178482

PVC Polyvinylchloride €/m

Deksel

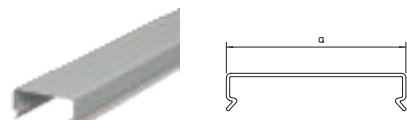

Type	Kleur	Afmeting a mm	Lengte mm	Verp. m	Gewicht kg/100 m	Bestelnr.
LK4 D 25	steengrijs	31	2000	32	10,000	6178482

PVC Polyvinylchloride €/m

Bedradingskoker, type LK4 30015

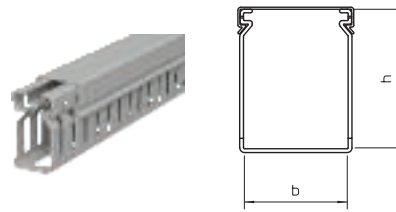

Type	Kleur	Lengte mm	B x H mm	Verp. m	Gewicht kg/100 m	Bestelnr.
LK4 30015	steengrijs	2000	15x30	40	18,000	6178003

PVC Polyvinylchloride €/m

Bedradingskoker, type LK4 30025

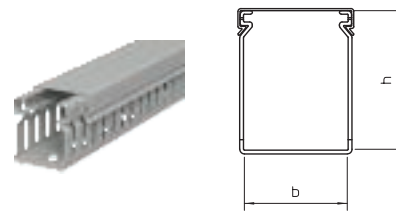

Type	Kleur	Lengte mm	B x H mm	Verp. m	Gewicht kg/100 m	Bestelnr.
LK4 30025	steengrijs	2000	25x30	48	28,000	6178005

PVC Polyvinylchloride €/m

Bedradingskoker, type LK4 40025

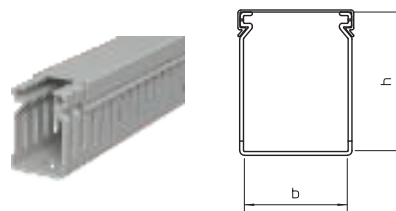

Type	Kleur	Lengte mm	B x H mm	Verp. m	Gewicht kg/100 m	Bestelnr.
LK4 40025	steengrijs	2000	25x40	48	36,500	6178010

PVC Polyvinylchloride €/m

Bedradingskoker, type LK4 40040

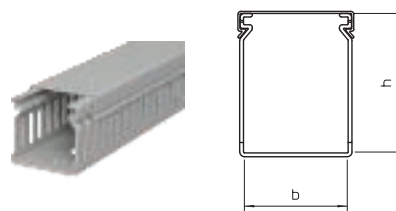

Type	Kleur	Lengte mm	B x H mm	Verp. m	Gewicht kg/100 m	Bestelnr.
LK4 40040	steengrijs	2000	40x40	36	44,000	6178012

PVC Polyvinylchloride €/m

Deksel

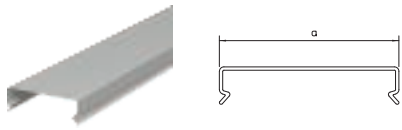

Type	Kleur	Afmeting a mm	Lengte mm	Verp. m	Gewicht kg/100 m	Bestelnr.
LK4 D 40	steengrijs	46,2	2000	24	13,500	6178484
PVC Polyvinylchloride € / m						

Deksel

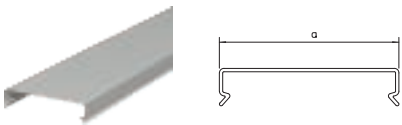

Type	Kleur	Afmeting a mm	Lengte mm	Verp. m	Gewicht kg/100 m	Bestelnr.
LK4 D 60	steengrijs	66,4	2000	40	18,000	6178486
PVC Polyvinylchloride € / m						

Deksel

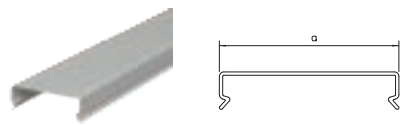

Type	Kleur	Afmeting a mm	Lengte mm	Verp. m	Gewicht kg/100 m	Bestelnr.
LK4 D 80	steengrijs	87	2000	12	27,000	6178488
PVC Polyvinylchloride € / m						

Deksel

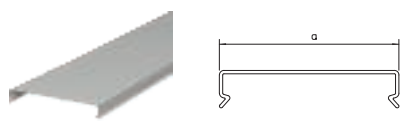

Type	Kleur	Afmeting a mm	Lengte mm	Verp. m	Gewicht kg/100 m	Bestelnr.
LK4 D 100	steengrijs	107,4	2000	12	35,500	6178490
PVC Polyvinylchloride € / m						

Bedradingskoker, type LK4 40060

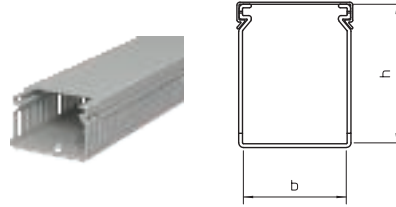

Type	Kleur	Lengte mm	Afmeting B x H mm	Verp. m	Gewicht kg/100 m	Bestelnr.
LK4 40060	steengrijs	2000	60x40	24	57,000	6178014
PVC Polyvinylchloride € / m						

Bedradingskoker, type LK4 40080

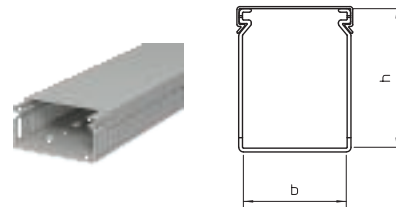

Type	Kleur	Lengte mm	Afmeting B x H mm	Verp. m	Gewicht kg/100 m	Bestelnr.
LK4 40080	steengrijs	2000	80x40	24	71,000	6178016
PVC Polyvinylchloride € / m						

Bedradingskoker, type LK4 40100

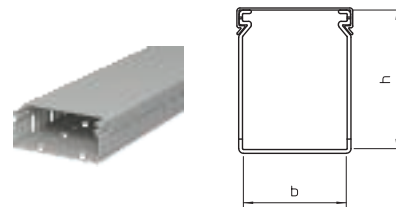

Type	Kleur	Lengte mm	Afmeting B x H mm	Verp. m	Gewicht kg/100 m	Bestelnr.
LK4 40100	steengrijs	2000	100x40	24	85,500	6178018
PVC Polyvinylchloride € / m						

Bedradingskoker, type LK4 60015

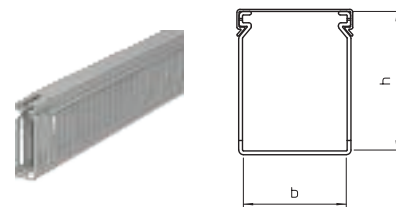

Type	Kleur	Lengte mm	Afmeting B x H mm	Verp. m	Gewicht kg/100 m	Bestelnr.
LK4 60015	steengrijs	2000	15x60	48	32,500	6178026
PVC Polyvinylchloride € / m						

Deksel

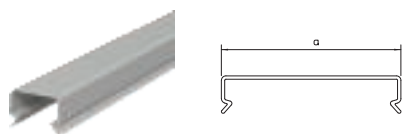

Type	Kleur	Afmeting a mm	Lengte mm	Verp. m	Gewicht kg/100 m	Bestelnr.
LK4 D 15	steengrijs	20	2000	92	8,500	6178480
PVC Polyvinylchloride € / m						

Deksel

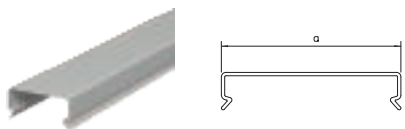

Type	Kleur	Afmeting a mm	Lengte mm	Verp. m	Gewicht kg/100 m	Bestelnr.
LK4 D 25	steengrijs	31	2000	32	10,000	6178482
PVC Polyvinylchloride € / m						

Deksel

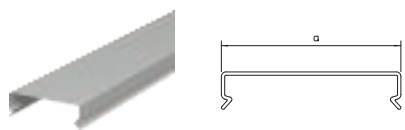

Type	Kleur	Afmeting a mm	Lengte mm	Verp. m	Gewicht kg/100 m	Bestelnr.
LK4 D 40	steengrijs	46,2	2000	24	13,500	6178484
PVC Polyvinylchloride € / m						

Deksel

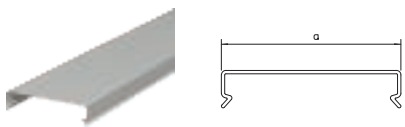

Type	Kleur	Afmeting a mm	Lengte mm	Verp. m	Gewicht kg/100 m	Bestelnr.
LK4 D 60	steengrijs	66,4	2000	40	18,000	6178486
PVC Polyvinylchloride € / m						

Bedradingskoker, type LK4 60025

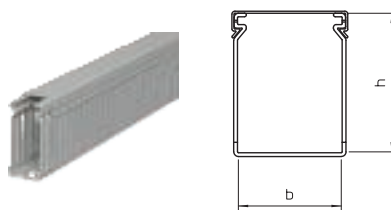

Type	Kleur	Lengte mm	Afmeting B x H mm	Verp. m	Gewicht kg/100 m	Bestelnr.
LK4 60025	steengrijs	2000	25x60	32	46,000	6178028
PVC Polyvinylchloride € / m						

Bedradingskoker, type LK4 60040

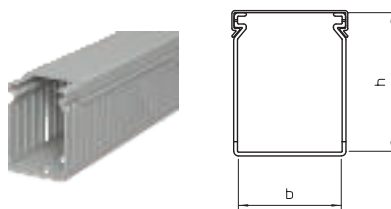

Type	Kleur	Lengte mm	Afmeting B x H mm	Verp. m	Gewicht kg/100 m	Bestelnr.
LK4 60040	steengrijs	2000	40x60	24	53,500	6178031
PVC Polyvinylchloride € / m						

Bedradingskoker, type LK4 60060

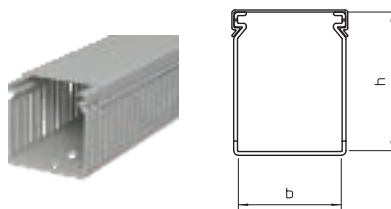

Type	Kleur	Lengte mm	Afmeting B x H mm	Verp. m	Gewicht kg/100 m	Bestelnr.
LK4 60060	steengrijs	2000	60x60	32	64,500	6178033
PVC Polyvinylchloride € / m						

Bedradingskoker, type LK4 60080

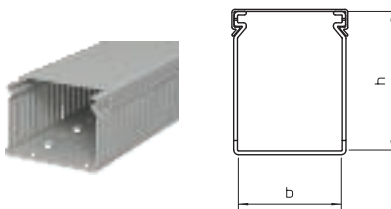

Type	Kleur	Lengte mm	Afmeting B x H mm	Verp. m	Gewicht kg/100 m	Bestelnr.
LK4 60080	steengrijs	2000	80x60	24	82,500	6178035
PVC Polyvinylchloride € / m						

Deksel

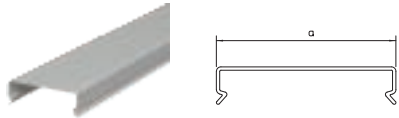

Type	Kleur	Afmeting a mm	Lengte mm	Verp. m	Gewicht kg/100 m	Bestelnr.
LK4 D 80	steengrijs	87	2000	12	27,000	6178488
PVC Polyvinylchloride € / m						

Deksel

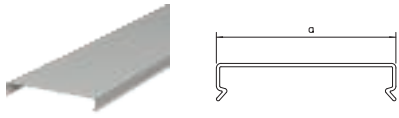

Type	Kleur	Afmeting a mm	Lengte mm	Verp. m	Gewicht kg/100 m	Bestelnr.
LK4 D 100	steengrijs	107,4	2000	12	35,500	6178490
PVC Polyvinylchloride € / m						

Deksel

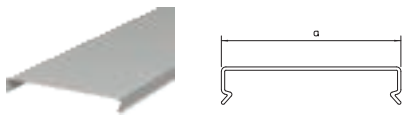

Type	Kleur	Afmeting a mm	Lengte mm	Verp. m	Gewicht kg/100 m	Bestelnr.
LK4 D 120	steengrijs	127,8	2000	16	45,500	6178492
PVC Polyvinylchloride € / m						

Deksel

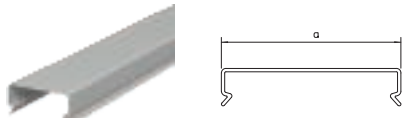

Type	Kleur	Afmeting a mm	Lengte mm	Verp. m	Gewicht kg/100 m	Bestelnr.
LK4 D 25	steengrijs	31	2000	32	10,000	6178482
PVC Polyvinylchloride € / m						

Bedradingskoker, type LK4 60100

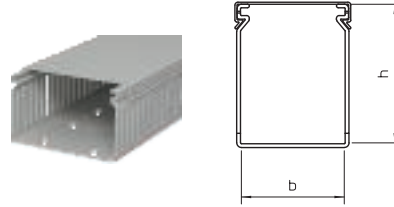

Type	Kleur	Lengte mm	B x H mm	Verp. m	Gewicht kg/100 m	Bestelnr.
LK4 60100	steengrijs	2000	100x60	16	100,000	6178037
PVC Polyvinylchloride € / m						

Bedradingskoker, type LK4 60120

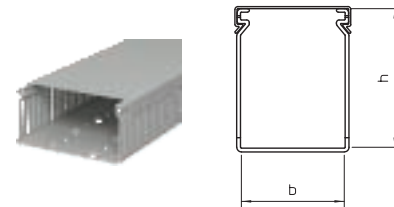

Type	Kleur	Lengte mm	B x H mm	Verp. m	Gewicht kg/100 m	Bestelnr.
LK4 60120	steengrijs	2000	120x60	8	117,000	6178039
PVC Polyvinylchloride € / m						

Bedradingskoker, type LK4 80025

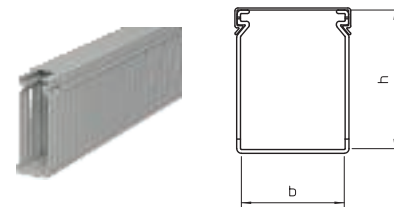

Type	Kleur	Lengte mm	B x H mm	Verp. m	Gewicht kg/100 m	Bestelnr.
LK4 80025	steengrijs	2000	25x80	32	61,000	6178050
PVC Polyvinylchloride € / m						

Bedradingskoker, type LK4 80040

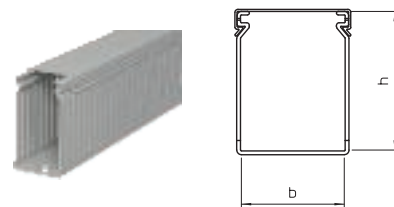

Type	Kleur	Lengte mm	B x H mm	Verp. m	Gewicht kg/100 m	Bestelnr.
LK4 80040	steengrijs	2000	40x80	24	64,500	6178052
PVC Polyvinylchloride € / m						

Deksel

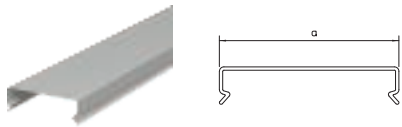

Type	Kleur	Afmeting a mm	Lengte mm	Verp. m	Gewicht kg/100 m	Bestelnr.
LK4 D 40	steengrijs	46,2	2000	24	13,500	6178484
PVC Polyvinylchloride €/m						

Deksel

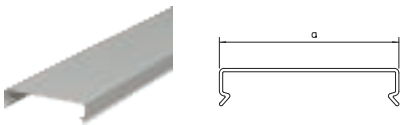

Type	Kleur	Afmeting a mm	Lengte mm	Verp. m	Gewicht kg/100 m	Bestelnr.
LK4 D 60	steengrijs	66,4	2000	40	18,000	6178486
PVC Polyvinylchloride €/m						

Deksel

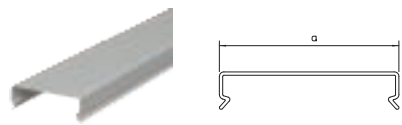

Type	Kleur	Afmeting a mm	Lengte mm	Verp. m	Gewicht kg/100 m	Bestelnr.
LK4 D 80	steengrijs	87	2000	12	27,000	6178488
PVC Polyvinylchloride €/m						

Deksel

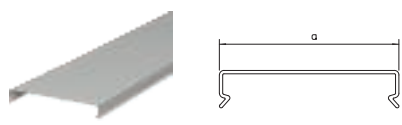

Type	Kleur	Afmeting a mm	Lengte mm	Verp. m	Gewicht kg/100 m	Bestelnr.
LK4 D 100	steengrijs	107,4	2000	12	35,500	6178490
PVC Polyvinylchloride €/m						

Bedradingskoker, type LK4 80060

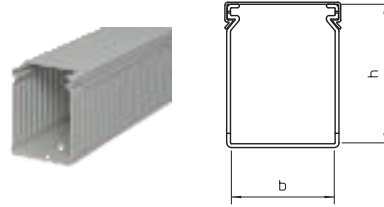

Type	Kleur	Lengte mm	Afmeting B x H mm	Verp. m	Gewicht kg/100 m	Bestelnr.
LK4 80060	steengrijs	2000	60x80	24	76,000	6178054
PVC Polyvinylchloride €/m						

Bedradingskoker, type LK4 80080

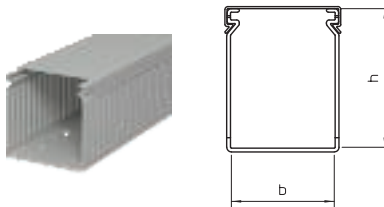

Type	Kleur	Lengte mm	Afmeting B x H mm	Verp. m	Gewicht kg/100 m	Bestelnr.
LK4 80080	steengrijs	2000	80x80	16	95,500	6178056
PVC Polyvinylchloride €/m						

Bedradingskoker, type LK4 80100

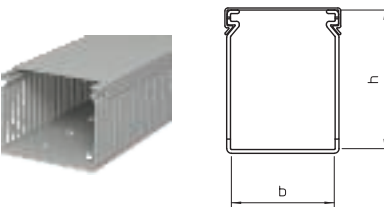

Type	Kleur	Lengte mm	Afmeting B x H mm	Verp. m	Gewicht kg/100 m	Bestelnr.
LK4 80100	steengrijs	2000	100x80	16	111,500	6178059
PVC Polyvinylchloride €/m						

Bedradingskoker, type LK4 80120

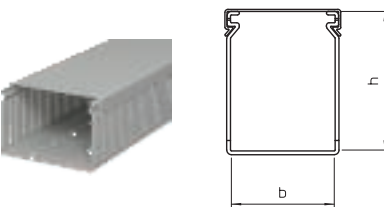

Type	Kleur	Lengte mm	Afmeting B x H mm	Verp. m	Gewicht kg/100 m	Bestelnr.
LK4 80120	steengrijs	2000	120x80	8	128,500	6178061
PVC Polyvinylchloride €/m						

Deksel

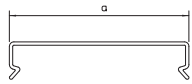

Type	Kleur	Afmeting a mm	Lengte mm	Verp. m	Gewicht kg/100 m	Bestelnr.
LK4 D 120	steengrijs	127,8	2000	16	45,500	6178492
PVC	Polyvinylchloride					€/m

Bedradingskoker, type LK4/N 60015

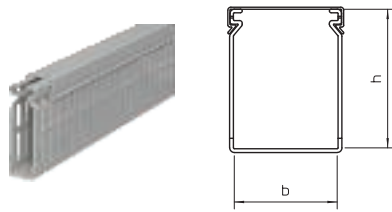

Type	Kleur	Lengte mm	Af-meting B x H mm	Verp. m	Gewicht kg/100 m	Bestelnr.
LK4 N 60015	steengrijs	2000	15x60	48	41,000	6178201

PVC Polyvinylchloride € / m

Deksel

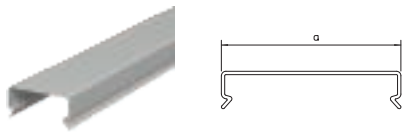

Type	Kleur	Lengte mm	Af-meting a mm	Verp. m	Gewicht kg/100 m	Bestelnr.
LK4 D 25	steengrijs	2000	31	32	10,000	6178482

PVC Polyvinylchloride € / m

Bedradingskoker, type LK4/N 60040

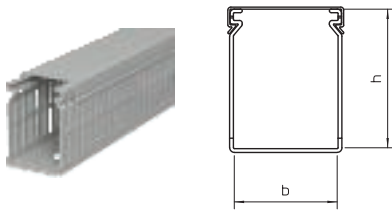

Type	Kleur	Lengte mm	Af-meting B x H mm	Verp. m	Gewicht kg/100 m	Bestelnr.
LK4 N 60040	steengrijs	2000	40x60	24	56,000	6178205

PVC Polyvinylchloride € / m

Deksel

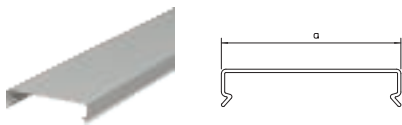

Type	Kleur	Lengte mm	Af-meting a mm	Verp. m	Gewicht kg/100 m	Bestelnr.
LK4 D 60	steengrijs	2000	66,4	40	18,000	6178486

PVC Polyvinylchloride € / m

Deksel

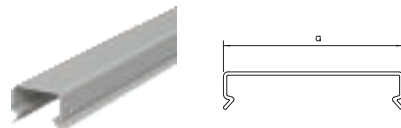

Type	Kleur	Lengte mm	Af-meting a mm	Verp. m	Gewicht kg/100 m	Bestelnr.
LK4 D 15	steengrijs	2000	20	92	8,500	6178480

PVC Polyvinylchloride € / m

Bedradingskoker, type LK4/N 60025

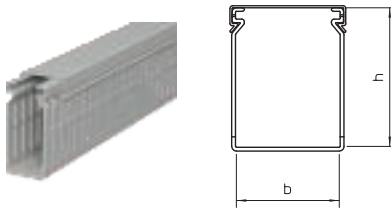

Type	Kleur	Lengte mm	Af-meting B x H mm	Verp. m	Gewicht kg/100 m	Bestelnr.
LK4 N 60025	steengrijs	2000	25x60	32	48,500	6178203

PVC Polyvinylchloride € / m

Deksel

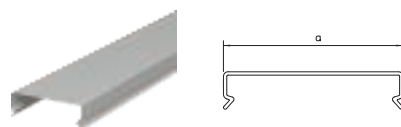

Type	Kleur	Lengte mm	Af-meting a mm	Verp. m	Gewicht kg/100 m	Bestelnr.
LK4 D 40	steengrijs	2000	46,2	24	13,500	6178484

PVC Polyvinylchloride € / m

Bedradingskoker, type LK4/N 60060

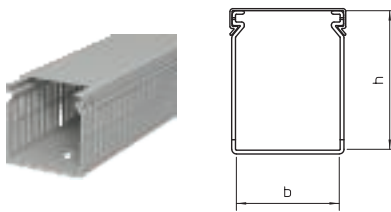

Type	Kleur	Lengte mm	Af-meting B x H mm	Verp. m	Gewicht kg/100 m	Bestelnr.
LK4 N 60060	steengrijs	2000	60x60	32	68,000	6178207

PVC Polyvinylchloride € / m

Bedradingskoker, type LK4/N 60080

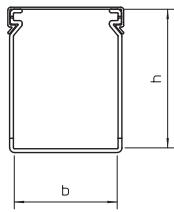

Type	Kleur	Lengte mm	Af-meting B x H mm	Verp. m	Gewicht kg/100 m	Bestelnr.
LK4 N 60080	steengrijs	2000	80x60	24	87,000	6178209

PVC Polyvinylchloride € / m

Deksel

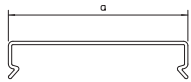

Type	Kleur	Af-meting a mm	Lengte mm	Verp. m	Gewicht kg/100 m	Bestelnr.
LK4 D 100	steengrijs	107,4	2000	12	35,500	6178490

PVC Polyvinylchloride € / m

Bedradingskoker, type LK4/N 60120

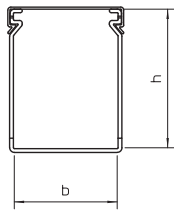

Type	Kleur	Lengte mm	Af-meting B x H mm	Verp. m	Gewicht kg/100 m	Bestelnr.
LK4 N 60120	steengrijs	2000	120x60	8	120,500	6178213

PVC Polyvinylchloride € / m

Deksel

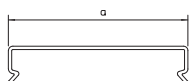

Type	Kleur	Af-meting a mm	Lengte mm	Verp. m	Gewicht kg/100 m	Bestelnr.
LK4 D 25	steengrijs	31	2000	32	10,000	6178482

PVC Polyvinylchloride € / m

Deksel

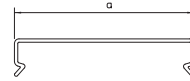

Type	Kleur	Af-meting a mm	Lengte mm	Verp. m	Gewicht kg/100 m	Bestelnr.
LK4 D 80	steengrijs	87	2000	12	27,000	6178488

PVC Polyvinylchloride € / m

Bedradingskoker, type LK4/N 60100

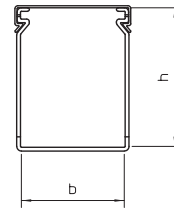

Type	Kleur	Lengte mm	Af-meting B x H mm	Verp. m	Gewicht kg/100 m	Bestelnr.
LK4 N 60100	steengrijs	2000	100x60	16	105,500	6178211

PVC Polyvinylchloride € / m

Deksel

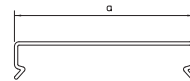

Type	Kleur	Af-meting a mm	Lengte mm	Verp. m	Gewicht kg/100 m	Bestelnr.
LK4 D 120	steengrijs	127,8	2000	16	45,500	6178492

PVC Polyvinylchloride € / m

Bedradingskoker, type LK4/N 80025

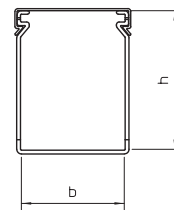

Type	Kleur	Lengte mm	Af-meting B x H mm	Verp. m	Gewicht kg/100 m	Bestelnr.
LK4 N 80025	steengrijs	2000	25x80	32	65,000	6178225

PVC Polyvinylchloride € / m

Bedradingskoker, type LK4/N 80040

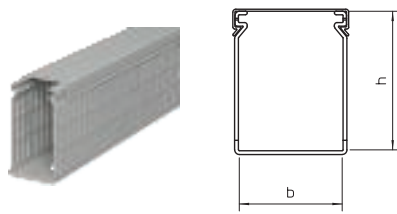

Type	Kleur	Lengte mm	B x H mm	Verp. m	Gewicht kg/100 m	Bestelnr.
LK4 N 80040	steengrijs	2000	40x80	24	73,500	6178227

PVC Polyvinylchloride € / m

Deksel

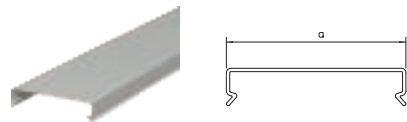

Type	Kleur	Afmeting a mm	Lengte mm	Verp. m	Gewicht kg/100 m	Bestelnr.
LK4 D 60	steengrijs	66,4	2000	40	18,000	6178486

PVC Polyvinylchloride € / m

Bedradingskoker, type LK4/N 80080

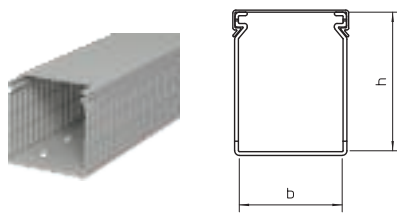

Type	Kleur	Lengte mm	B x H mm	Verp. m	Gewicht kg/100 m	Bestelnr.
LK4 N 80080	steengrijs	2000	80x80	16	101,000	6178231

PVC Polyvinylchloride € / m

Deksel

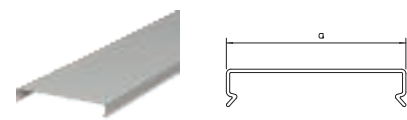

Type	Kleur	Afmeting a mm	Lengte mm	Verp. m	Gewicht kg/100 m	Bestelnr.
LK4 D 100	steengrijs	107,4	2000	12	35,500	6178490

PVC Polyvinylchloride € / m

Deksel

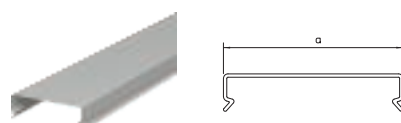

Type	Kleur	Afmeting a mm	Lengte mm	Verp. m	Gewicht kg/100 m	Bestelnr.
LK4 D 40	steengrijs	46,2	2000	24	13,500	6178484

PVC Polyvinylchloride € / m

Bedradingskoker, type LK4/N 80060

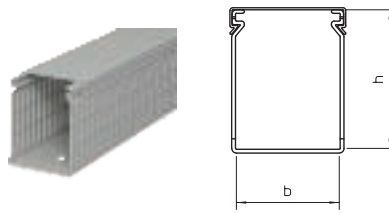

Type	Kleur	Lengte mm	B x H mm	Verp. m	Gewicht kg/100 m	Bestelnr.
LK4 N 80060	steengrijs	2000	60x80	24	82,000	6178229

PVC Polyvinylchloride € / m

Deksel

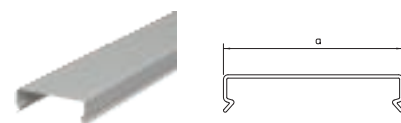

Type	Kleur	Afmeting a mm	Lengte mm	Verp. m	Gewicht kg/100 m	Bestelnr.
LK4 D 80	steengrijs	87	2000	12	27,000	6178488

PVC Polyvinylchloride € / m

Bedradingskoker, type LK4/N 80100

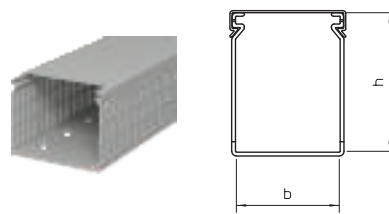

Type	Kleur	Lengte mm	B x H mm	Verp. m	Gewicht kg/100 m	Bestelnr.
LK4 N 80100	steengrijs	2000	100x80	16	116,500	6178233

PVC Polyvinylchloride € / m

Bedradingskoker, type LK4/N 80120

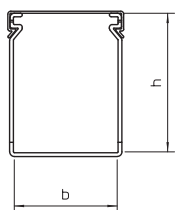

Type	Kleur	Lengte mm	Af- meting B x H mm	Verp. m	Gewicht kg/100 m	Bestelnr.
LK4 N 80120	steengrijs	2000	120x80	8	133,500	6178236
PVC	Polyvinylchloride					€/m

Deksel

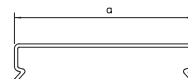

Type	Kleur	Afme- ting a mm	Lengte mm	Verp. m	Gewicht kg/100 m	Bestelnr.
LK4 D 120	steengrijs	127,8	2000	16	45,500	6178492
PVC	Polyvinylchloride					€/m

Bedradingskoker, type 25025

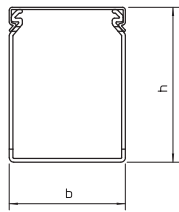

Type	Kleur	Lengte mm	B x H mm	Verp. m	Gewicht kg/100 m	Bestelnr.
LKV 25025	steengrijs	2000	25x25	32	24,000	6178302
PVC Polyvinylchloride € / m						

Deksel

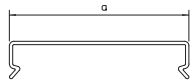

Type	Kleur	Afmeting a mm	Lengte mm	Verp. m	Gewicht kg/100 m	Bestelnr.
LKV D 25	steengrijs	25	2000	36	9,500	6178504
PVC Polyvinylchloride € / m						

Bedradingskoker, type 37037

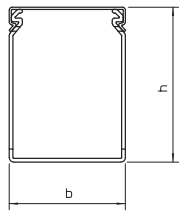

Type	Kleur	Lengte mm	B x H mm	Verp. m	Gewicht kg/100 m	Bestelnr.
LKV 37037	steengrijs	2000	37,5x37,5	60	40,500	6178307
PVC Polyvinylchloride € / m						

Deksel

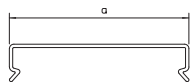

Type	Kleur	Afmeting a mm	Lengte mm	Verp. m	Gewicht kg/100 m	Bestelnr.
LKV D 25	steengrijs	25	2000	36	9,500	6178504
PVC Polyvinylchloride € / m						

Deksel

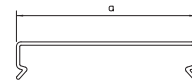

Type	Kleur	Afmeting a mm	Lengte mm	Verp. m	Gewicht kg/100 m	Bestelnr.
LKV D 25	steengrijs	25	2000	36	9,500	6178504
PVC Polyvinylchloride € / m						

Bedradingskoker, type 37025

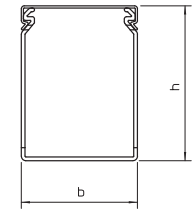

Type	Kleur	Lengte mm	B x H mm	Verp. m	Gewicht kg/100 m	Bestelnr.
LKV 37025	steengrijs	2000	25x37,5	32	31,500	6178305
PVC Polyvinylchloride € / m						

Deksel

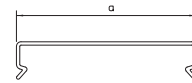

Type	Kleur	Afmeting a mm	Lengte mm	Verp. m	Gewicht kg/100 m	Bestelnr.
LKV D 37	steengrijs	37,5	2000	24	15,000	6178506
PVC Polyvinylchloride € / m						

Bedradingskoker, type 50025

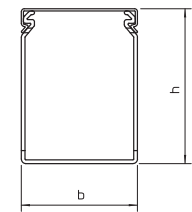

Type	Kleur	Lengte mm	B x H mm	Verp. m	Gewicht kg/100 m	Bestelnr.
LKV 50025	steengrijs	2000	25x50	60	35,500	6178310
PVC Polyvinylchloride € / m						

Bedradingskoker, type 50037

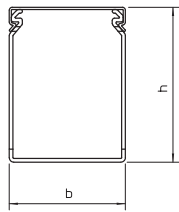

Type	Kleur	Lengte mm	B x H mm	Verp. m	Gewicht kg/100 m	Bestelnr.
LKV 50037	steengrijs	2000	37,5x50	48	44,500	6178312

PVC Polyvinylchloride € / m

Deksel

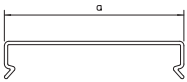

Type	Kleur	Afmeting a mm	Lengte mm	Verp. m	Gewicht kg/100 m	Bestelnr.
LKV D 50	steengrijs	50	2000	24	17,500	6178508

PVC Polyvinylchloride € / m

Bedradingskoker, type 50075

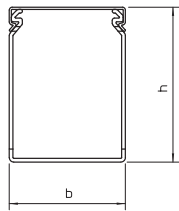

Type	Kleur	Lengte mm	B x H mm	Verp. m	Gewicht kg/100 m	Bestelnr.
LKV 50075	steengrijs	2000	75x50	24	66,000	6178316

PVC Polyvinylchloride € / m

Deksel

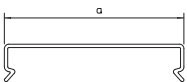

Type	Kleur	Afmeting a mm	Lengte mm	Verp. m	Gewicht kg/100 m	Bestelnr.
LKV D 25	steengrijs	25	2000	36	9,500	6178504

PVC Polyvinylchloride € / m

Deksel

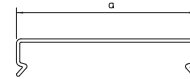

Type	Kleur	Afmeting a mm	Lengte mm	Verp. m	Gewicht kg/100 m	Bestelnr.
LKV D 37	steengrijs	37,5	2000	24	15,000	6178506

PVC Polyvinylchloride € / m

Bedradingskoker, type 50050

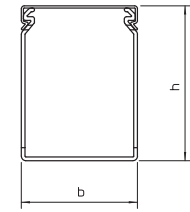

Type	Kleur	Lengte mm	B x H mm	Verp. m	Gewicht kg/100 m	Bestelnr.
LKV 50050	steengrijs	2000	50x50	36	50,000	6178314

PVC Polyvinylchloride € / m

Deksel

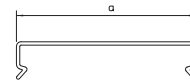

Type	Kleur	Afmeting a mm	Lengte mm	Verp. m	Gewicht kg/100 m	Bestelnr.
LKV D 75	steengrijs	75	2000	12	23,000	6178510

PVC Polyvinylchloride € / m

Bedradingskoker, type 75025

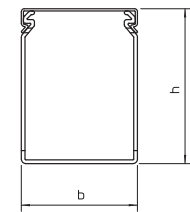

Type	Kleur	Lengte mm	B x H mm	Verp. m	Gewicht kg/100 m	Bestelnr.
LKV 75025	steengrijs	2000	25x75	40	48,500	6178320

PVC Polyvinylchloride € / m

Bedradingskoker, type 75037

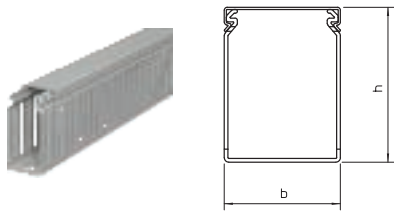

Type	Kleur	Lengte mm	B x H mm	Verp. m	Gewicht kg/100 m	Bestelnr.
LKV 75037	steengrijs	2000	37,5x75	32	58,500	6178322
PVC Polyvinylchloride € / m						

Deksel

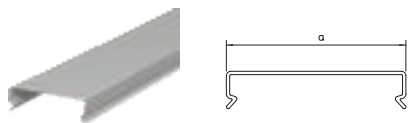

Type	Kleur	Afmeting a mm	Lengte mm	Verp. m	Gewicht kg/100 m	Bestelnr.
LKV D 50	steengrijs	50	2000	24	17,500	6178508
PVC Polyvinylchloride € / m						

Bedradingskoker, type 75075

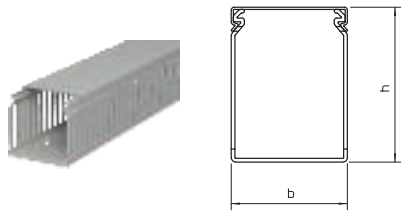

Type	Kleur	Lengte mm	B x H mm	Verp. m	Gewicht kg/100 m	Bestelnr.
LKV 75075	steengrijs	2000	75x75	16	80,000	6178326
PVC Polyvinylchloride € / m						

Deksel

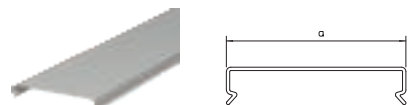

Type	Kleur	Afmeting a mm	Lengte mm	Verp. m	Gewicht kg/100 m	Bestelnr.
LKV D 100	steengrijs	100	2000	12	34,500	6178512
PVC Polyvinylchloride € / m						

Deksel

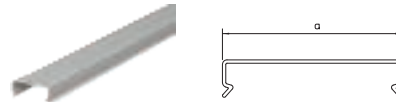

Type	Kleur	Afmeting a mm	Lengte mm	Verp. m	Gewicht kg/100 m	Bestelnr.
LKV D 37	steengrijs	37,5	2000	24	15,000	6178506
PVC Polyvinylchloride € / m						

Bedradingskoker, type 75050

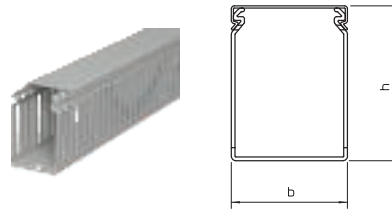

Type	Kleur	Lengte mm	B x H mm	Verp. m	Gewicht kg/100 m	Bestelnr.
LKV 75050	steengrijs	2000	50x75	24	67,500	6178324
PVC Polyvinylchloride € / m						

Deksel

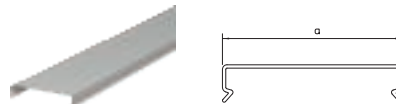

Type	Kleur	Afmeting a mm	Lengte mm	Verp. m	Gewicht kg/100 m	Bestelnr.
LKV D 75	steengrijs	75	2000	12	23,000	6178510
PVC Polyvinylchloride € / m						

Bedradingskoker, type 75100

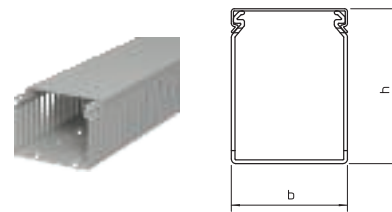

Type	Kleur	Lengte mm	B x H mm	Verp. m	Gewicht kg/100 m	Bestelnr.
LKV 75100	steengrijs	2000	100x75	16	105,500	6178328
PVC Polyvinylchloride € / m						

Bedradingskoker, type 75125

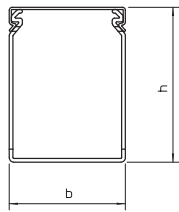

Type	Kleur	Lengte mm	B x H mm	Verp. m	Gewicht kg/100 m	Bestelnr.
LKV 75125	steengrijs	2000	125x75	8	128,500	6178330
PVC Polyvinylchloride € / m						

Deksel

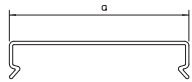

Type	Kleur	Afmeting a mm	Lengte mm	Verp. m	Gewicht kg/100 m	Bestelnr.
LKV D 37	steengrijs	37,5	2000	24	15,000	6178506
PVC Polyvinylchloride € / m						

Bedradingskoker, type 10050

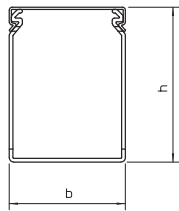

Type	Kleur	Lengte mm	B x H mm	Verp. m	Gewicht kg/100 m	Bestelnr.
LKV 10050	steengrijs	2000	50x100	24	77,000	6178336
PVC Polyvinylchloride € / m						

Deksel

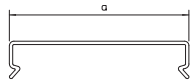

Type	Kleur	Afmeting a mm	Lengte mm	Verp. m	Gewicht kg/100 m	Bestelnr.
LKV D 75	steengrijs	75	2000	12	23,000	6178510
PVC Polyvinylchloride € / m						

Deksel

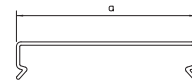

Type	Kleur	Afmeting a mm	Lengte mm	Verp. m	Gewicht kg/100 m	Bestelnr.
LKV D 125	steengrijs	125	2000	16	47,000	6178514
PVC Polyvinylchloride € / m						

Bedradingskoker, type 10037

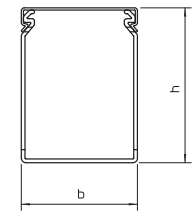

Type	Kleur	Lengte mm	B x H mm	Verp. m	Gewicht kg/100 m	Bestelnr.
LKV 10037	steengrijs	2000	37,5x100	32	67,000	6178334
PVC Polyvinylchloride € / m						

Deksel

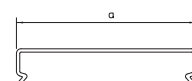

Type	Kleur	Afmeting a mm	Lengte mm	Verp. m	Gewicht kg/100 m	Bestelnr.
LKV D 50	steengrijs	50	2000	24	17,500	6178508
PVC Polyvinylchloride € / m						

Bedradingskoker, type 10075

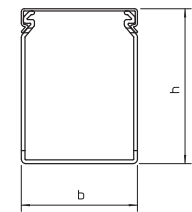

Type	Kleur	Lengte mm	B x H mm	Verp. m	Gewicht kg/100 m	Bestelnr.
LKV 10075	steengrijs	2000	75x100	16	96,000	6178338
PVC Polyvinylchloride € / m						

Bedradingskoker, type 100100

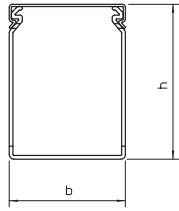

Type	Kleur	Lengte mm	Af- meting B x H mm	Verp. m	Gewicht kg/100 m	Bestelnr.
LKV 100100	steengrijs	2000	100x100	8	116,500	6178341
PVC Polyvinylchloride € / m						

Deksel

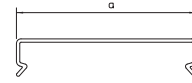

Type	Kleur	Afme- ting a mm	Lengte mm	Verp. m	Gewicht kg/100 m	Bestelnr.
LKV D 100	steengrijs	100	2000	12	34,500	6178512
PVC Polyvinylchloride € / m						

Bedradingskoker, type 75025

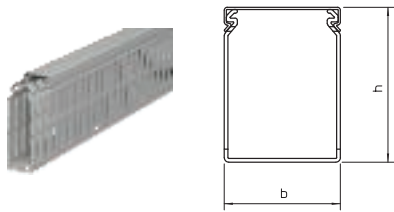

Type	Kleur	Lengte mm	Af-meting B x H mm	Verp. m	Gewicht kg/100 m	Bestelnr.
LKV N 75025	steengrijs	2000	25x75	40	49,500	6178420
PVC Polyvinylchloride € / m						

Deksel

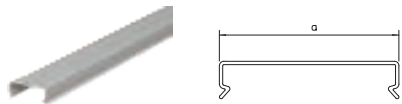

Type	Kleur	Af-meting a mm	Lengte mm	Verp. m	Gewicht kg/100 m	Bestelnr.
LKV D 37	steengrijs	37,5	2000	24	15,000	6178506
PVC Polyvinylchloride € / m						

Bedradingskoker, type 75050

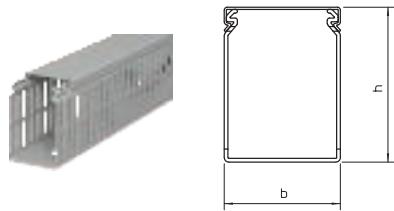

Type	Kleur	Lengte mm	Af-meting B x H mm	Verp. m	Gewicht kg/100 m	Bestelnr.
LKV N 75050	steengrijs	2000	50x75	24	72,500	6178424
PVC Polyvinylchloride € / m						

Deksel

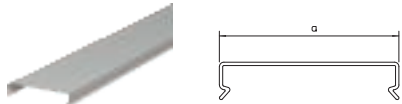

Type	Kleur	Af-meting a mm	Lengte mm	Verp. m	Gewicht kg/100 m	Bestelnr.
LKV D 75	steengrijs	75	2000	12	23,000	6178510
PVC Polyvinylchloride € / m						

Deksel

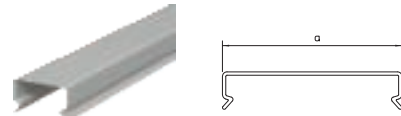

Type	Kleur	Af-meting a mm	Lengte mm	Verp. m	Gewicht kg/100 m	Bestelnr.
LKV D 25	steengrijs	25	2000	36	9,500	6178504
PVC Polyvinylchloride € / m						

Bedradingskoker, type 75037

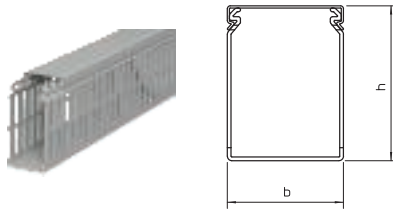

Type	Kleur	Lengte mm	Af-meting B x H mm	Verp. m	Gewicht kg/100 m	Bestelnr.
LKV N 75037	steengrijs	2000	37,5x75	32	60,500	6178422
PVC Polyvinylchloride € / m						

Deksel

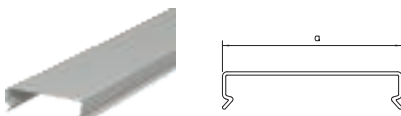

Type	Kleur	Af-meting a mm	Lengte mm	Verp. m	Gewicht kg/100 m	Bestelnr.
LKV D 50	steengrijs	50	2000	24	17,500	6178508
PVC Polyvinylchloride € / m						

Bedradingskoker, type 75075

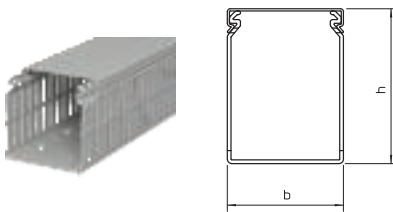

Type	Kleur	Lengte mm	Af-meting B x H mm	Verp. m	Gewicht kg/100 m	Bestelnr.
LKV N 75075	steengrijs	2000	75x75	16	84,500	6178426
PVC Polyvinylchloride € / m						

Bedradingskoker, type 75100

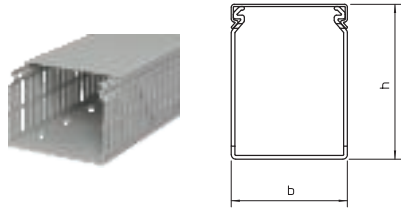

Type	Kleur	Lengte mm	Af- meting B x H mm	Verp. m	Gewicht kg/100 m	Bestelnr.
LKV N 75100	steengrijs	2000	100x75	16	112,000	6178428
PVC Polyvinylchloride € / m						

Deksel

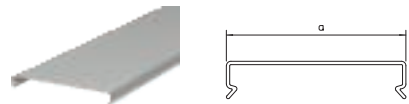

Type	Kleur	Afme- ting a mm	Lengte mm	Verp. m	Gewicht kg/100 m	Bestelnr.
LKV D 125	steengrijs	125	2000	16	47,000	6178514
PVC Polyvinylchloride € / m						

Bedradingskoker, type 10037

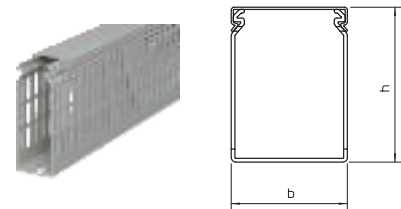

Type	Kleur	Lengte mm	Af- meting B x H mm	Verp. m	Gewicht kg/100 m	Bestelnr.
LKV N 10037	steengrijs	2000	37,5x100	32	73,000	6178435
PVC Polyvinylchloride € / m						

Deksel

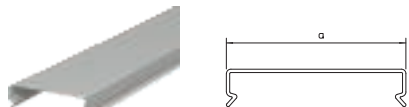

Type	Kleur	Afme- ting a mm	Lengte mm	Verp. m	Gewicht kg/100 m	Bestelnr.
LKV D 50	steengrijs	50	2000	24	17,500	6178508
PVC Polyvinylchloride € / m						

Deksel

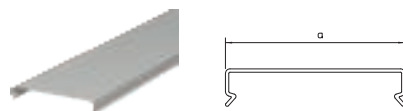

Type	Kleur	Afme- ting a mm	Lengte mm	Verp. m	Gewicht kg/100 m	Bestelnr.
LKV D 100	steengrijs	100	2000	12	34,500	6178512
PVC Polyvinylchloride € / m						

Bedradingskoker, type 75125

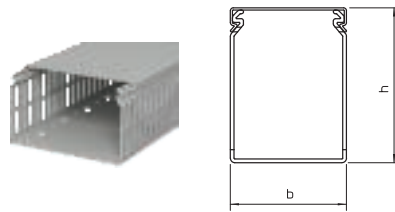

Type	Kleur	Lengte mm	Af- meting B x H mm	Verp. m	Gewicht kg/100 m	Bestelnr.
LKV N 75125	steengrijs	2000	125x75	8	138,500	6178430
PVC Polyvinylchloride € / m						

Deksel

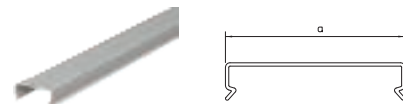

Type	Kleur	Afme- ting a mm	Lengte mm	Verp. m	Gewicht kg/100 m	Bestelnr.
LKV D 37	steengrijs	37,5	2000	24	15,000	6178506
PVC Polyvinylchloride € / m						

Bedradingskoker, type 10050

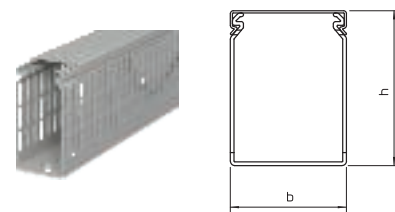

Type	Kleur	Lengte mm	Af- meting B x H mm	Verp. m	Gewicht kg/100 m	Bestelnr.
LKV N 10050	steengrijs	2000	50x100	24	83,000	6178437
PVC Polyvinylchloride € / m						

Bedradingskoker, type 10075

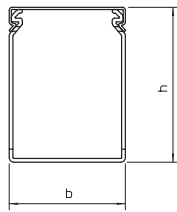

Type	Kleur	Lengte mm	Af- meting B x H mm	Verp. m	Gewicht kg/100 m	Bestelnr.
LKV N 10075	steengrijs	2000	75x100	16	102,000	6178439
PVC Polyvinylchloride € / m						

Deksel

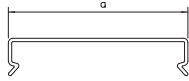

Type	Kleur	Af- meting a mm	Lengte mm	Verp. m	Gewicht kg/100 m	Bestelnr.
LKV D 100	steengrijs	100	2000	12	34,500	6178512
PVC Polyvinylchloride € / m						

Deksel

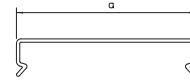

Type	Kleur	Af- meting a mm	Lengte mm	Verp. m	Gewicht kg/100 m	Bestelnr.
LKV D 75	steengrijs	75	2000	12	23,000	6178510
PVC Polyvinylchloride € / m						

Bedradingskoker, type 100100

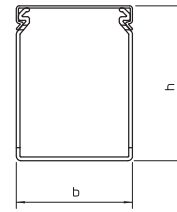

Type	Kleur	Lengte mm	Af- meting B x H mm	Verp. m	Gewicht kg/100 m	Bestelnr.
LKV N 100100	steengrijs	2000	100x100	8	122,500	6178441
PVC Polyvinylchloride € / m						

Draadhouderbrug voor type LK4 en LK4/N

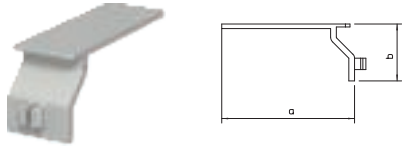

Type	Kleur	Afmeting a mm	Afmeting b mm	Verp. Stuk	Gewicht kg/100 st.	Bestelnr.
LK4 H	steengrijs	56	25	100	0,348	6178092
PS Polystyreen						€/100 st.

Draadhouderbrug voor type LKV en LKV/N

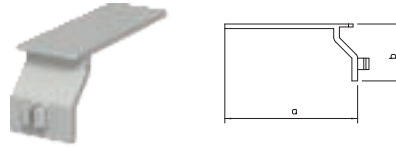

Type	Kleur	Afmeting a mm	Afmeting b mm	Verp. Stuk	Gewicht kg/100 st.	Bestelnr.
LKV H	steengrijs	56	25	100	0,470	6178349
PS Polystyreen						€/100 st.

Kunststof nietapparaat

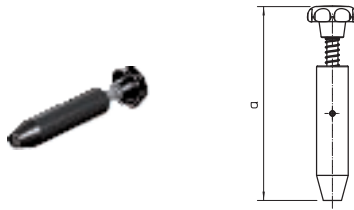

Type	Dimensie	Kleur	Verp. Stuk	Gewicht kg/100 st.	Bestelnr.
KNW1	Ø 4,5mm	zwart	1	9,300	6178527
POM Polyacetal (polyoxymethyleen, polyformaldehyde)					

€/st.

Kunststof nietapparaat

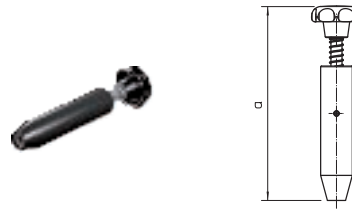

Type	Dimensie	Kleur	Verp. Stuk	Gewicht kg/100 st.	Bestelnr.
KNW2	Ø 6mm	zwart	1	9,400	6178529
POM Polyacetal (polyoxymethyleen, polyformaldehyde)					

€/st.

Splijtnagel, KSN 1

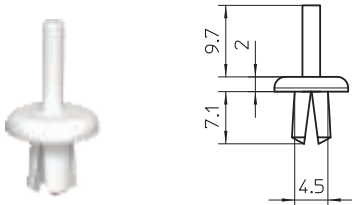

Type	Kleur	Afmeting a mm	Verp. Stuk	Gewicht kg/100 st.	Bestelnr.
KSN1	lichtgrijs	4,5	100	0,026	6178520
PP Polypropyleen					

€/100 st.

Splijtnagel, KSN 22

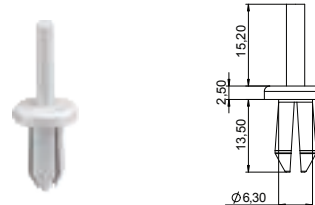

Type	Kleur	Afmeting a mm	Verp. Stuk	Gewicht kg/100 st.	Bestelnr.
KSN22	lichtgrijs	6,3	100	0,070	6178525
PA Polyamide					

€/100 st.

Uitbrektang



Type	Verp. Stuk	Gewicht kg/100 st.	Bestelnr.
AKZ	1	30,857	6178535
St Staal			

€/st.

Afstandshouder

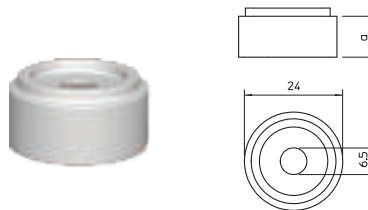

Type	Kleur	Afmeting a mm	Diameter mm	Verp. Stuk	Gewicht kg/100 st.	Bestelnr.
AH1	grijs	12	24	100	0,354	6178540
AH2	grijs	20	24	100	0,577	6178542
PVC Polyvinylchloride						

€/100 st.

Nivelleerring

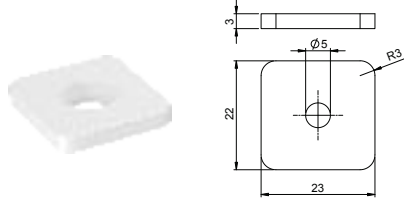

Type	Kleur	Afmeting h mm	Diameter mm	Verp. Stuk	Gewicht kg/100 st.	Bestelnr.
ULS	grijs	3	5	100	0,170	6178548

PVC Polyvinylchloride € /100 st.

Draagrail, geperforeerd

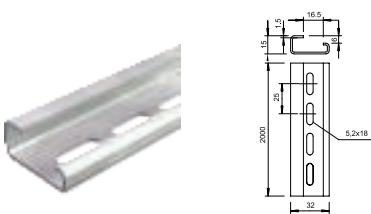

Type	Uitvoering	Materiaal-dikte mm	Lengte mm	Bundel m	Gewicht kg/100 m	Bestelnr.
2064 GTP	geperforeerd	1,5	2000	20	69,000	1115065

Staal € /100 m
GTP galvanisch verzinkt, transparant gepassiveerd

DIN-rail, geperforeerd

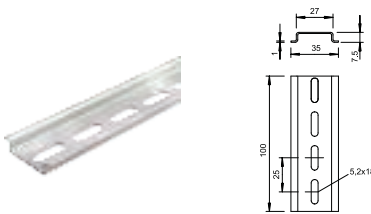

Type	Uitvoering	Materiaal-dikte mm	Lengte mm	Bundel m	Gewicht kg/100 m	Bestelnr.
2069 2M GTP	geperforeerd	1	2000	50	33,280	1115669

Staal € /100 m
GTP galvanisch verzinkt, transparant gepassiveerd

Draagrail, niet geperforeerd

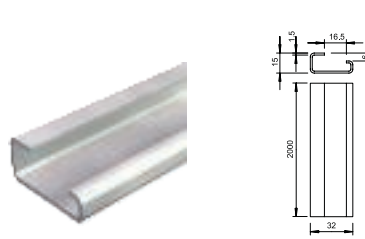

Type	Uitvoering	Materiaal-dikte mm	Lengte mm	Bundel m	Gewicht kg/100 m	Bestelnr.
2064 GTP 2M	ongeperforeerd	1,5	2000	20	70,000	1115057

Staal € /100 m
GTP galvanisch verzinkt, transparant gepassiveerd

DIN-rail, niet geperforeerd

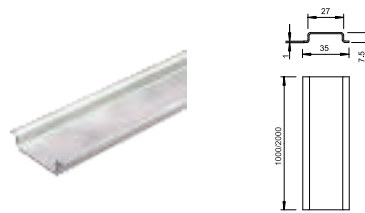

Type	Uitvoering	Materiaal-dikte mm	Lengte mm	Bundel m	Gewicht kg/100 m	Bestelnr.
2069 2M GTP	ongeperforeerd	1	2000	50	36,040	1115650

Staal € /100 m
GTP galvanisch verzinkt, transparant gepassiveerd

Coderingsplaat



Type	Afmeting mm	Kleur	Verp. Stuk	Gewicht kg/100 st.	Bestelnr.
VK ISCS 5012	99x25mm	lichtblauw	20	0,100	6178643

€/st.



VKH bedradingskoker
Halogeenvrij

VKH bedradingskoker, halogeenvrij



LKVH DIN bedradingskoker, halogeenvrij

36



Toebehoren VK bedradingskoker halogeenvrij

38

Bedradingskoker, type 50037

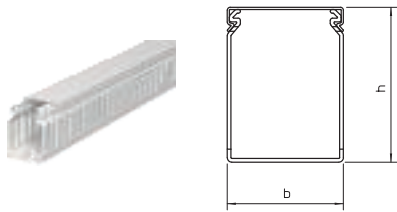

Type	Kleur	Lengte mm	Afmeting B x H mm	Verp. m	Gewicht kg/100 m	Bestelnr.
LKVH 50037	lichtgrijs	2000	37,5x50	48	32,000	6178582

PC/ABS Polycarbonaat/acrylnitriël-butadiëen-styrol €/m

Deksel

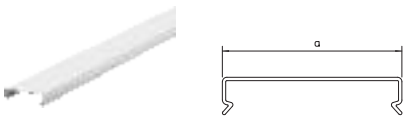

Type	Kleur	Afmeting a mm	Lengte mm	Verp. m	Gewicht kg/100 m	Bestelnr.
LKVH D 50	lichtgrijs	50	2000	24	11,000	6178674

PC/ABS Polycarbonaat/acrylnitriël-butadiëen-styrol €/m

Bedradingskoker, type 50075

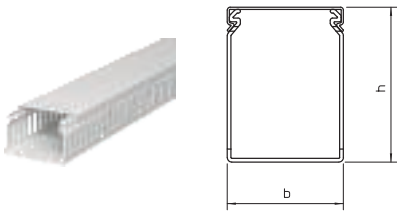

Type	Kleur	Lengte mm	Afmeting B x H mm	Verp. m	Gewicht kg/100 m	Bestelnr.
LKVH 50075	lichtgrijs	2000	75x50	24	52,000	6178588

PC/ABS Polycarbonaat/acrylnitriël-butadiëen-styrol €/m

Deksel



Type	Kleur	Afmeting a mm	Lengte mm	Verp. m	Gewicht kg/100 m	Bestelnr.
LKVH D 37	lichtgrijs	37,5	2000	24	8,500	6178670

PC/ABS Polycarbonaat/acrylnitriël-butadiëen-styrol €/m

Deksel

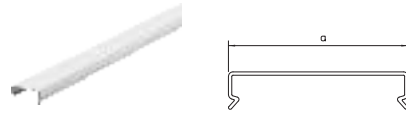

Type	Kleur	Afmeting a mm	Lengte mm	Verp. m	Gewicht kg/100 m	Bestelnr.
LKVH D 37	lichtgrijs	37,5	2000	24	8,500	6178670

PC/ABS Polycarbonaat/acrylnitriël-butadiëen-styrol €/m

Bedradingskoker, type 50050

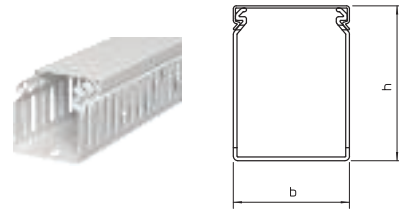

Type	Kleur	Lengte mm	Afmeting B x H mm	Verp. m	Gewicht kg/100 m	Bestelnr.
LKVH 50050	lichtgrijs	2000	50x50	36	37,000	6178585

PC/ABS Polycarbonaat/acrylnitriël-butadiëen-styrol €/m

Deksel

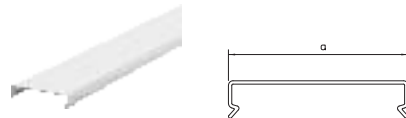

Type	Kleur	Afmeting a mm	Lengte mm	Verp. m	Gewicht kg/100 m	Bestelnr.
LKVH D 75	lichtgrijs	75	2000	12	18,000	6178678

PC/ABS Polycarbonaat/acrylnitriël-butadiëen-styrol €/m

Bedradingskoker, type 75037

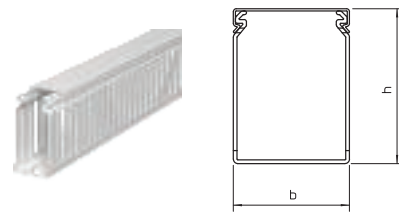

Type	Kleur	Lengte mm	Afmeting B x H mm	Verp. m	Gewicht kg/100 m	Bestelnr.
LKVH N 75037	lichtgrijs	2000	37,5x75	32	44,000	6178552

PC/ABS Polycarbonaat/acrylnitriël-butadiëen-styrol €/m

Bedradingskoker, type 75050

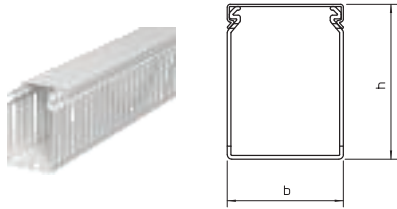

Type	Kleur	Lengte mm	B x H mm	Verp. m	Gewicht kg/100 m	Bestelnr.
LKVH N 75050	lichtgrijs	2000	50x75	24	51,000	6178556
PC/ABS Polycarbonaat/acrylnitriël-butadiëen-styrol € / m						

Deksel

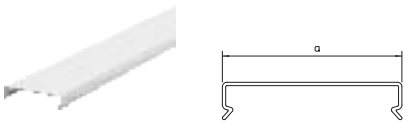

Type	Kleur	Afmeting a mm	Lengte mm	Verp. m	Gewicht kg/100 m	Bestelnr.
LKVH D 75	lichtgrijs	75	2000	12	18,000	6178678
PC/ABS Polycarbonaat/acrylnitriël-butadiëen-styrol € / m						

Bedradingskoker, type 75100

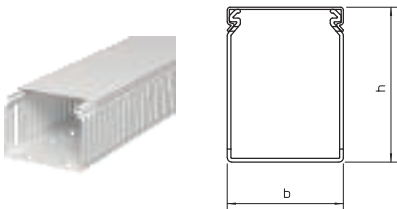

Type	Kleur	Lengte mm	B x H mm	Verp. m	Gewicht kg/100 m	Bestelnr.
LKVH N 75100	lichtgrijs	2000	100x75	16	84,000	6178563
PC/ABS Polycarbonaat/acrylnitriël-butadiëen-styrol € / m						

Deksel



Type	Kleur	Afmeting a mm	Lengte mm	Verp. m	Gewicht kg/100 m	Bestelnr.
LKVH D 125	lichtgrijs	125	2000	16	34,500	6178686
PC/ABS Polycarbonaat/acrylnitriël-butadiëen-styrol € / m						

Deksel

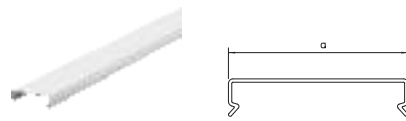

Type	Kleur	Afmeting a mm	Lengte mm	Verp. m	Gewicht kg/100 m	Bestelnr.
LKVH D 50	lichtgrijs	50	2000	24	11,000	6178674
PC/ABS Polycarbonaat/acrylnitriël-butadiëen-styrol € / m						

Bedradingskoker, type 75075

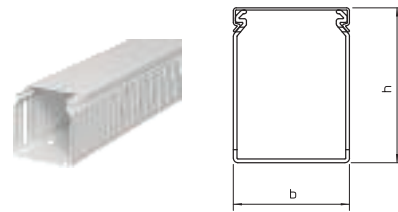

Type	Kleur	Lengte mm	B x H mm	Verp. m	Gewicht kg/100 m	Bestelnr.
LKVH N 75075	lichtgrijs	2000	75x75	16	64,000	6178559
PC/ABS Polycarbonaat/acrylnitriël-butadiëen-styrol € / m						

Deksel

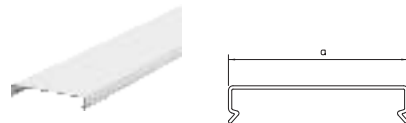

Type	Kleur	Afmeting a mm	Lengte mm	Verp. m	Gewicht kg/100 m	Bestelnr.
LKVH D 100	lichtgrijs	100	2000	12	27,500	6178682
PC/ABS Polycarbonaat/acrylnitriël-butadiëen-styrol € / m						

Bedradingskoker, type 75125

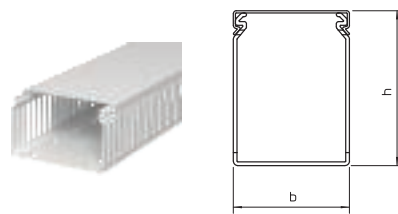

Type	Kleur	Lengte mm	B x H mm	Verp. m	Gewicht kg/100 m	Bestelnr.
LKVH N 75125	lichtgrijs	2000	125x75	8	98,500	6178566
PC/ABS Polycarbonaat/acrylnitriël-butadiëen-styrol € / m						

Draadhouderbrug voor type LKV/H

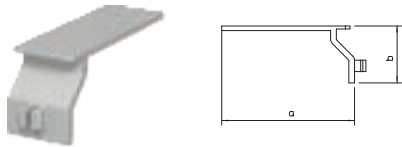

Type	Kleur	Afmeting a mm	Afmeting b mm	Verp. Stuk	Gewicht kg/100 st.	Bestelnr.
LKV H H	lichtgrijs	56	25	100	0,349	6178650

PS Polystyreen € /100 st.

Splijtnagel, KSN 1

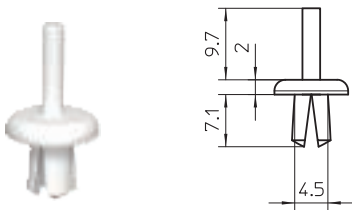

Type	Kleur	Afmeting a mm	Verp. Stuk	Gewicht kg/100 st.	Bestelnr.
KSN1	lichtgrijs	4,5	100	0,026	6178520

PP Polypropyleen € /100 st.

Uitbrektang



Type	Verp. Stuk	Gewicht kg/100 st.	Bestelnr.
AKZ	1	30,857	6178535

St Staal € /st.

Draagrail, geperforeerd

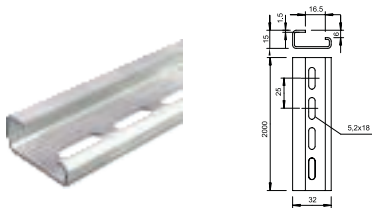

Type	Uitvoering	Materiaal-dikte mm	Lengte mm	Bundel m	Gewicht kg/100 m	Bestelnr.
2064 GTP L 2M	geperforeerd	1,5	2000	20	69,000	1115065

St Staal € /100 m
GTP galvanisch verzinkt, transparant gepasseveerd

Kunststof nietapparaat

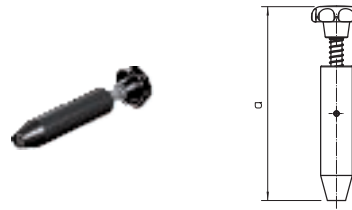

Type	Dimensie	Kleur	Verp. Stuk	Gewicht kg/100 st.	Bestelnr.
KNW1	Ø 4,5mm	zwart	1	9,300	6178527

POM Polyacetal (polyoxymethyleen, polyformaldehyde) € /st.

Kunststof nietapparaat

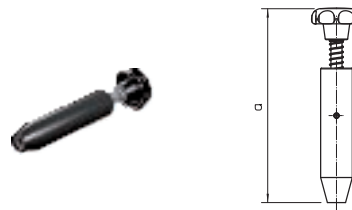

Type	Dimensie	Kleur	Verp. Stuk	Gewicht kg/100 st.	Bestelnr.
KNW2	Ø 6mm	zwart	1	9,400	6178529

POM Polyacetal (polyoxymethyleen, polyformaldehyde) € /st.

Splijtnagel, KSN 22

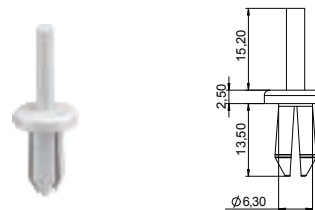

Type	Kleur	Afmeting a mm	Verp. Stuk	Gewicht kg/100 st.	Bestelnr.
KSN22	lichtgrijs	6,3	100	0,070	6178525

PA Polyamide € /100 st.

Draagrail, niet geperforeerd

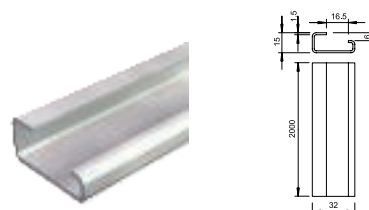

Type	Uitvoering	Materiaal-dikte mm	Lengte mm	Bundel m	Gewicht kg/100 m	Bestelnr.
2064 GTP 2M	ongeperforeerd	1,5	2000	20	70,000	1115057

St Staal € /100 m
GTP galvanisch verzinkt, transparant gepasseveerd

DIN-rail, niet geperforeerd

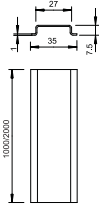

Mate-
riaal-
dikte

Type	Uitvoering	mm	Lengte mm	Bundel m	Gewicht kg/100 m	Bestelnr.
2069 2M GTP	ongeperforeerd	1	2000	50	36,040	1115650

St Staal

€/100 m

GTP galvanisch verzinkt, transparant gepassiveerd

DIN-rail, geperforeerd

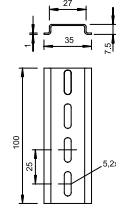

Mate-
riaal-
dikte

Type	Uitvoering	mm	Lengte mm	Bundel m	Gewicht kg/100 m	Bestelnr.
2069 2M GTPL	geperforeerd	1	2000	50	33,280	1115669

St Staal

€/100 m

GTP galvanisch verzinkt, transparant gepassiveerd

OBO Bettermann B.V.
Postbus 114
3640 AC Mijdrecht

Klantenservice:
Tel.: 0297-515700
Fax: 0297-515760
E-mail: info@obo-bettermann.nl

www.obo-bettermann.nl

Building Connections

